

MUSEUM

**CHICAGO**



MUSEUM

UNIQUE SURFACES

**SUMMARY**  
**// RESUMEN**

# Welcome to Chicago: // Bienvenido a Chicago:

**NEW COLLECTION, NEW HORIZONS**  
**// NUEVA COLECCIÓN, NUEVOS HORIZONTES**

**4D WALL // 4D WALL**

page 4  
// pág. 4

**20 MM THICKNESS // ESPESOR 20 MM**

page 6  
// pág. 6

**The Story // La historia**

page 8  
// pág. 8

**Graphics // Gráficas**

page 12  
// pág. 12

**Finishes and formats // Acabados y formatos**

page 20  
// pág. 20

**Technical information // Información técnica**

page 24  
// pág. 24



# 4D WALL

50 x 150 cm

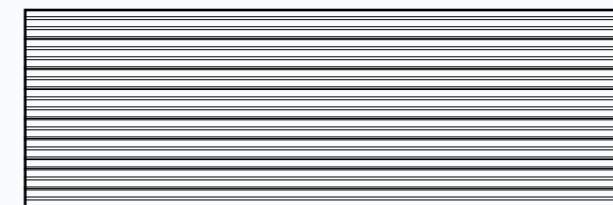
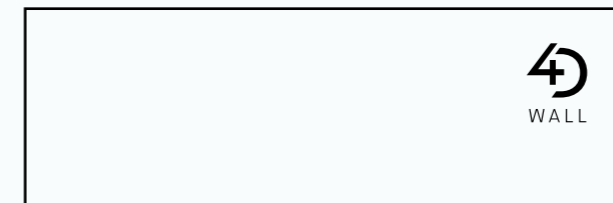

Finishes // Acabados



Thickness // Espesor

7,5 mm

white body

Our new 4D WALL technology has revolutionized the concept of wall tiles as we know them. Its innovative white-body composition, large 50x150 cm format, and slimline 7.5 mm thickness make the indoor tile-laying process much simpler and quicker than ever before.

La nueva tecnología 4D WALL transforma el concepto de revestimiento conocido hasta el momento. Su innovadora composición cerámica en pasta blanca, unido al gran formato 50x150 cm y a su fino espesor de 7,5 mm permite simplificar todavía más la logística, manipulación y colocación en interiores.



**Easy installation:** big format and lightness that allows a faster cutting and placement.  
Fácil instalación: formato grande y ligero que permite un corte y colocación más rápido.



**More hygienic:** less joints make cleaning easier.  
Más higiénico: menos juntas que facilitan la limpieza.



**Eco-friendly:** reduction of emissions due to including recycled materials in the composition.  
Respetuoso con el medio ambiente: reducción de emisiones debido a que se incluye material reciclado en la composición.



# 20 mm *thickness*

100 x 100 cm

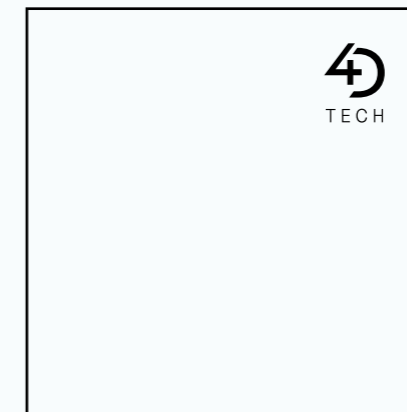

50 x 100 cm

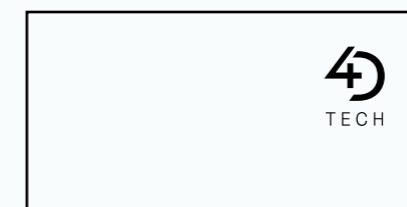

Our innovative 4D tech in large 100x100cm format reaches a 20mm thickness, to provide us with surfaces of extraordinary resistance for both residential and commercial areas.

It is a system adaptable to various outdoor surfaces, depending on whether it is installed on grass, sand, gravel, plots or with a traditional sealing system. Using the recommended gasket in each case.

Nuestra innovadora tecnología 4D en gran formato 100x100cm alcanza el espesor de 20mm, para proporcionarnos superficies de extraordinaria resistencia tanto para ámbito residencial como para ámbito comercial.

Es un sistema adaptable a diversas superficies de exterior, según si se instala sobre césped, arena, grava, plots o con sistema tradicional de sellado. Utilizando la junta recomendada en cada caso.

**Finish // Acabado**

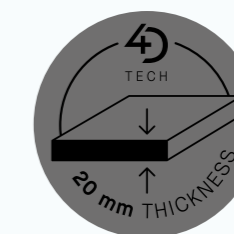

**resistance** *BREAK / WEATHER / SCRATCH / CHEMICALS*  
**resistencia** *ROTURA / CLIMA / RAYADURAS / QUÍMICOS*

**installation** *FAST / EASY*  
**instalación** *FÁCIL / RÁPIDA*

**aesthetics** *INDOOR&OUTDOOR / CHROMATISM / REPLACEABLE*  
**estética** *INTERIOR&EXTERIOR / CROMATISMO / SUSTITUIBLE*

**awareness** *RECYCLED / RECYCLABLE / LOW MAINTENANCE*  
**conciencia** *RECICLADO / RECICLABLE / BAJO MANTENIMIENTO*



## THE STORY // LA HISTORIA

Mark Twain once said:

"It is hopeless for the occasional visitor to try to keep up with Chicago. She outgrows his prophecies faster than he can make them. She is always a novelty; she is never the Chicago you saw when you passed through the last time"

As the city, this collection is cosmopolitan, sophisticated, exclusive and innovative.

**Welcome to Chicago, our new stone-effect collection.**

Mark Twain dijo una vez:

"Es inútil para el visitante ocasional intentar mantenerse al día con Chicago. Ella supera sus profecías más rápido de lo que él puede hacerlas. Ella es siempre una novedad; porque ella nunca es el Chicago que viste cuando pasaste por última vez"

Como la ciudad, esta colección es cosmopolita, sofisticada, exclusiva e innovadora.

**Bienvenido a Chicago, nuestra nueva colección pétreo.**



- ⊕ Chicago Road SP/100x275/R
- ⊖ Chicago Road SP/100x100/R



## GRAPHICS // GRÁFICAS

The CHICAGO collection features a restful looking stone pattern with a nebulous appearance, where one shade merges into the next, lending it a chic modern appearance.

It comes in a choice of four natural looking shades (Cloud, Road, Mocha and Moon) in a wide variety of formats (100x275 cm, 100x180 cm, 100x100 cm, 50x100 cm, 60x120 cm and 90x90 cm) and a Shaped, Natural or Antislip finish.

The collection also features a 50x150 cm model, made with brand new 4D WALL technology, conceived to bring an added natural appeal to living spaces, thanks to its size and unparalleled Shaped finish.

La colección CHICAGO representa una piedra calmada, cuya gráfica nebulosa se entremezcla tono sobre tono, adquiriendo un estilo de lo más contemporáneo.

Sus tonalidades naturales son cuatro: Cloud, Road, Mocha y Moon. En una gran variedad de formatos como son 100x275 cm, 100x180 cm, 100x100 cm, 50x100 cm, 60x120 cm o 90x90 cm, en los acabados Shaped, Natural y Antislip.

Además, se incorpora una nueva tecnología 4D WALL en formato 50x150 cm, para aportar mayor naturalidad a los espacios gracias a su dimensión y su acabado Shaped por excelencia.





⊕ Chicago Mocha SP/100x275/R // Chicago Mocha SP/100x180/R

⊖ Grow Porto SP/24x151/R



GRAPHIC VARIETY: 10 PATTERNS VARIEDAD GRÁFICA: 10 MODELOS

Chicago Mocha 100x180 cm



- ⊕ Chicago Moon SP/50x150/R
- ⊖ Chicago Moon SP/100x100/R

**FINISHES**  
**// ACABADOS**



**SHAPED**

Smooth texture, the graphic is perfectly coordinated with the relief.

Textura suave, la gráfica se coordina perfectamente con el relieve.



**NATURAL**

Smooth touch, a matte texture ideal for residential and commercial use.

Tacto liso, textura mate ideal para uso residencial y comercial.

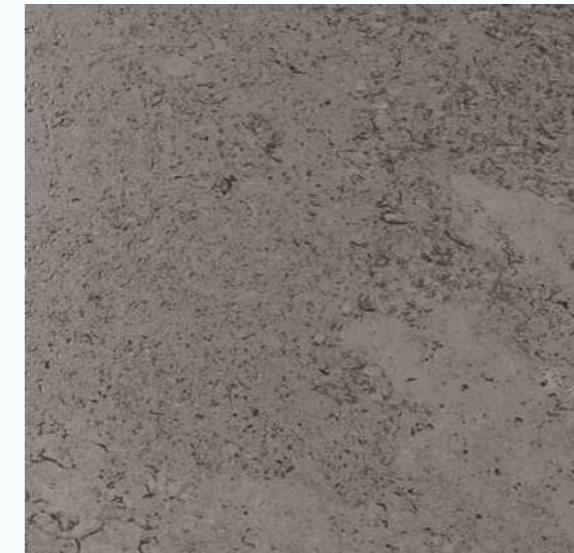

**ANTISLIP**

Textured surface with matte finish, recommended for outdoor use.

Superficie texturizada mate, recomendada para uso exterior.



**FORMATS**  
// **FORMATOS**

100 x 275 cm



**Finish // Acabado**



**Thickness // Espesor**

6 mm

100 x 180 cm



**Finish // Acabado**



**Thickness // Espesor**

8 mm

100 x 100 cm

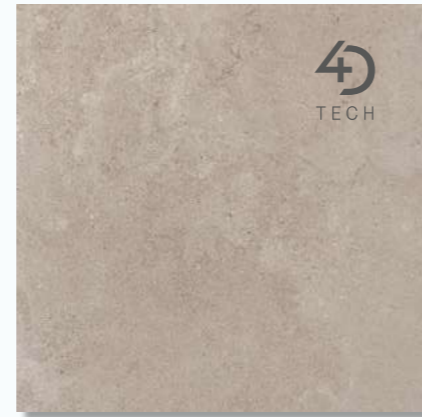

**Finish // Acabado**



**Thickness // Espesor**

8 mm

**Finish // Acabado**



**Thickness // Espesor**

20 mm

50 x 100 cm

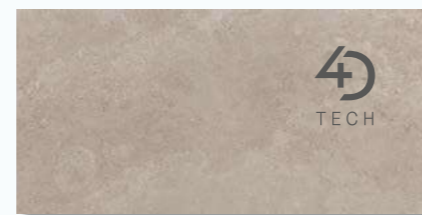

**Finish // Acabado**



**Thickness // Espesor**

20 mm

60 x 120 cm



**Finish // Acabado**



**Thickness // Espesor**

10 mm

90 x 90 cm



**Finishes // Acabados**



**Thickness // Espesor**

10 mm

50 x 150 cm



**Finish // Acabado**



**Thickness // Espesor**

7,5 mm

white body

# TECHNICAL INFORMATION // INFORMACIÓN TÉCNICA

## FINISHES // ACABADOS

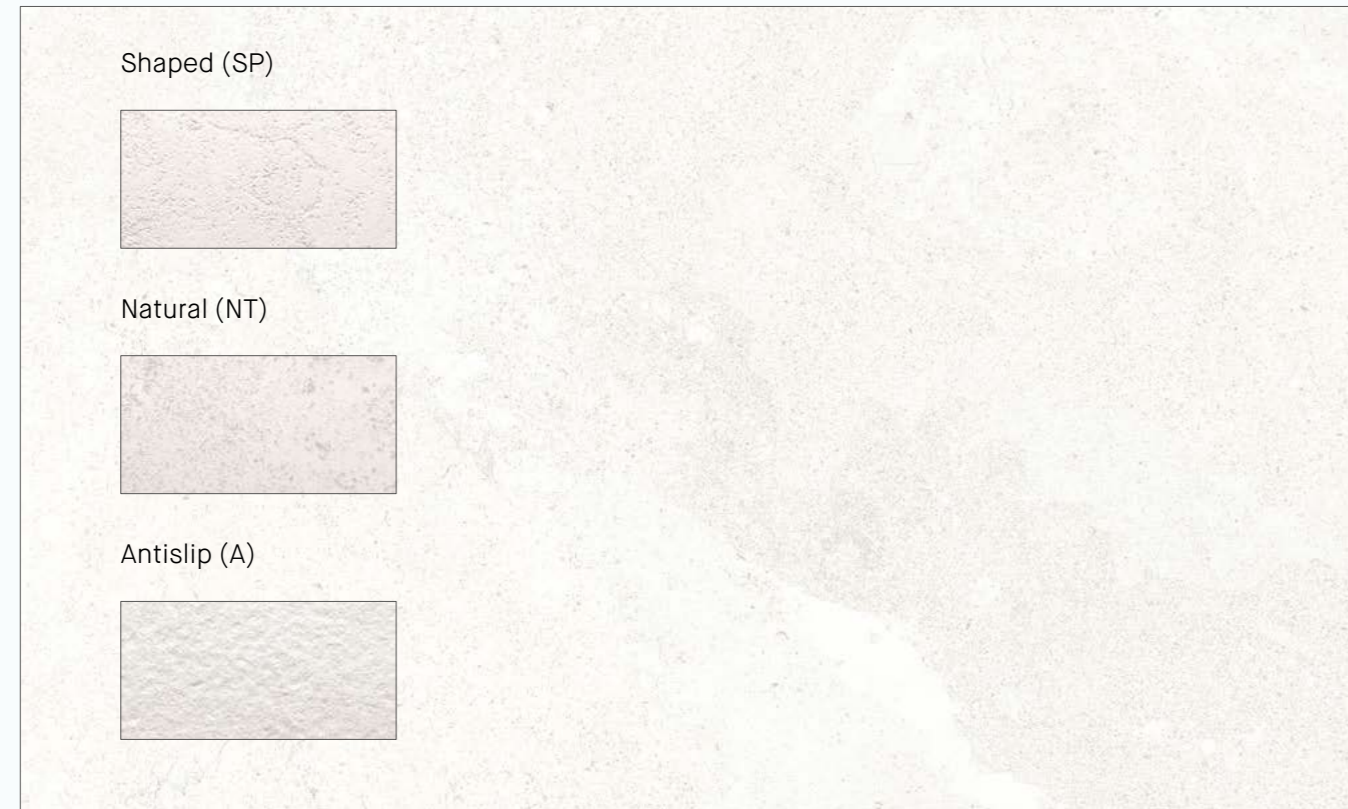

## COLOURS // COLORES



Cloud Road Mocha Moon

Porcelain Porcelánico

White Body Pasta Blanca

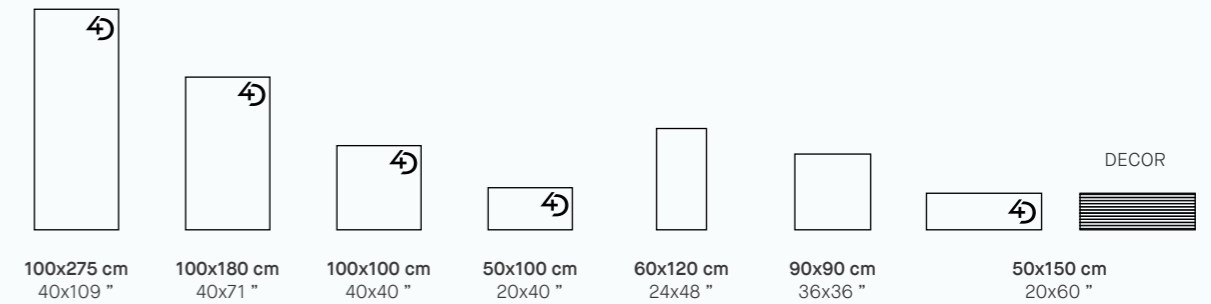





Thickness		6 mm	8 mm / 20 mm*		20 mm	10 mm		7,5 mm	
Patterns		10	10	10	10	20	12	18	18
CLOUD	Shaped (SP)	<b>35936</b> M90	<b>31758</b> M94	<b>31824</b> M93	-	-	-	<b>31967</b> M105	<b>31971</b> M106
	Natural (NT)	-	-	-	-	<b>31767</b> M101	<b>31883</b> M102	-	-
	Antislip (A)	-	-	<b>36389*</b> M113	<b>36803</b> M115	-	<b>31887</b> M81	-	-
ROAD	Shaped (SP)	<b>36618</b> M90	<b>31759</b> M94	<b>31827</b> M93	-	-	-	<b>31969</b> M105	<b>31974</b> M106
	Natural (NT)	-	-	-	-	<b>31769</b> M101	<b>31886</b> M102	-	-
	Antislip (A)	-	-	<b>36392*</b> M113	<b>36806</b> M115	-	<b>31888</b> M81	-	-
MOCHA	Shaped (SP)	<b>36619</b> M90	<b>31820</b> M94	<b>31825</b> M93	-	-	-	<b>31968</b> M105	<b>31972</b> M106
	Natural (NT)	-	-	-	-	<b>31821</b> M101	<b>31884</b> M102	-	-
	Antislip (A)	-	-	<b>36390*</b> M113	<b>36804</b> M115	-	<b>31889</b> M81	-	-
MOON	Shaped (SP)	<b>35922</b> M90	<b>31760</b> M94	<b>31826</b> M93	-	-	-	<b>31970</b> M105	<b>31973</b> M106
	Natural (NT)	-	-	-	-	<b>31768</b> M101	<b>31885</b> M102	-	-
	Antislip (A)	-	-	<b>36391*</b> M113	<b>36805</b> M115	-	<b>31890</b> M81	-	-

## TECHNICAL DATA // DATOS TÉCNICOS





	DIN 51130	DIN 51097	UNE-ENV 126 33	BS 7976-2 (PTV)	ANSI A137.1 (DCOF)
Shaped (SP) 8 mm	-	-	Class 1	-	>0,42 Wet
Natural (NT)	R10	A + B	Class 2	+36 Wet	>0,42 Wet
Antislip (A)	R11	A + B + C	Class 3	+36 Wet	>0,42 Wet

## SPECIAL PIECES // PIEZAS ESPECIALES



White Body Pasta Blanca (7,5 mm)

D. GEO * 25x25 cm 9.8x9.8 "			
	CLOUD	Shaped (SP)	32195 U58
	ROAD	Shaped (SP)	32196 U58
	MOCHA	Shaped (SP)	32197 U58
	MOON	Shaped (SP)	32198 U58

Porcelain Porcelánico (10 mm)

D. MOSAIC 30x30 cm 11.8x11.8 "			
	CLOUD	Natural (NT)	32200 U36
	ROAD	Natural (NT)	32201 U36
	MOCHA	Natural (NT)	32202 U36
	MOON	Natural (NT)	32203 U36



Porcelain Porcelánico (10 mm)

D. MIX ** 30x30 cm 11.8x11.8 "			
	CHICAGO MOON GROW DOLPHIN HAUTE WHITE	Natural (NT) Shaped (SP) Shaped (SP)	32073 U55
	DUAL WHITE GROW KALUA CHICAGO MOCHA	Natural (NT) Shaped (SP) Natural (NT)	32072 U55

\* Only suitable for wall installations.  
\* Adecuado únicamente como revestimiento.

\*\* Random colour position.  
\*\* Posición de colores aleatoria.

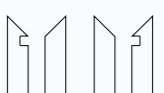
## COMPLEMENTARY PIECES // PIEZAS COMPLEMENTARIAS

S.K.I. S.K.D.		SKIRTING			
	8x30 cm 3.1x11.8 "		8x100 cm 3.1x39.4 "	8x90 cm 3.1x35.4 "	8x60 cm 3.1x23.6 "
Shaped (SP)	U53	Shaped (SP)	U45	-	-
Natural (NT)	U53	Natural (NT)	-	U44	U35
Antislip (A)	U53	Antislip (A)	-	U44	-

### STAIR TREADS

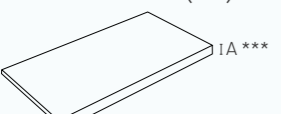
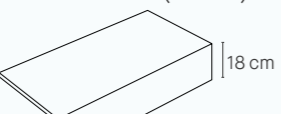
TECHNICAL (PT)		SEAMLESS (PL/18)		*** When thickness is 6 mm, A = 18 mm; when 8 mm, A = 24 mm; when 10 mm, A = 30 mm. *** Cuando el espesor es 6 mm, A = 18 mm; cuando es 8 mm, A = 24 mm; cuando es 10 mm, A = 30 mm.				
	IA ***		18 cm	30x180 cm 11.8x70.8 "	30x120 cm 11.8x47.2 "	30x100 cm 11.8x39.4 "	30x90 cm 11.8x35.4 "	30x60 cm 11.8x23.6 "
Shaped (SP)				U90	-	U74	-	-
Natural (NT)				-	U75	-	U76	U54
Antislip (A)				-	-	-	U76	-

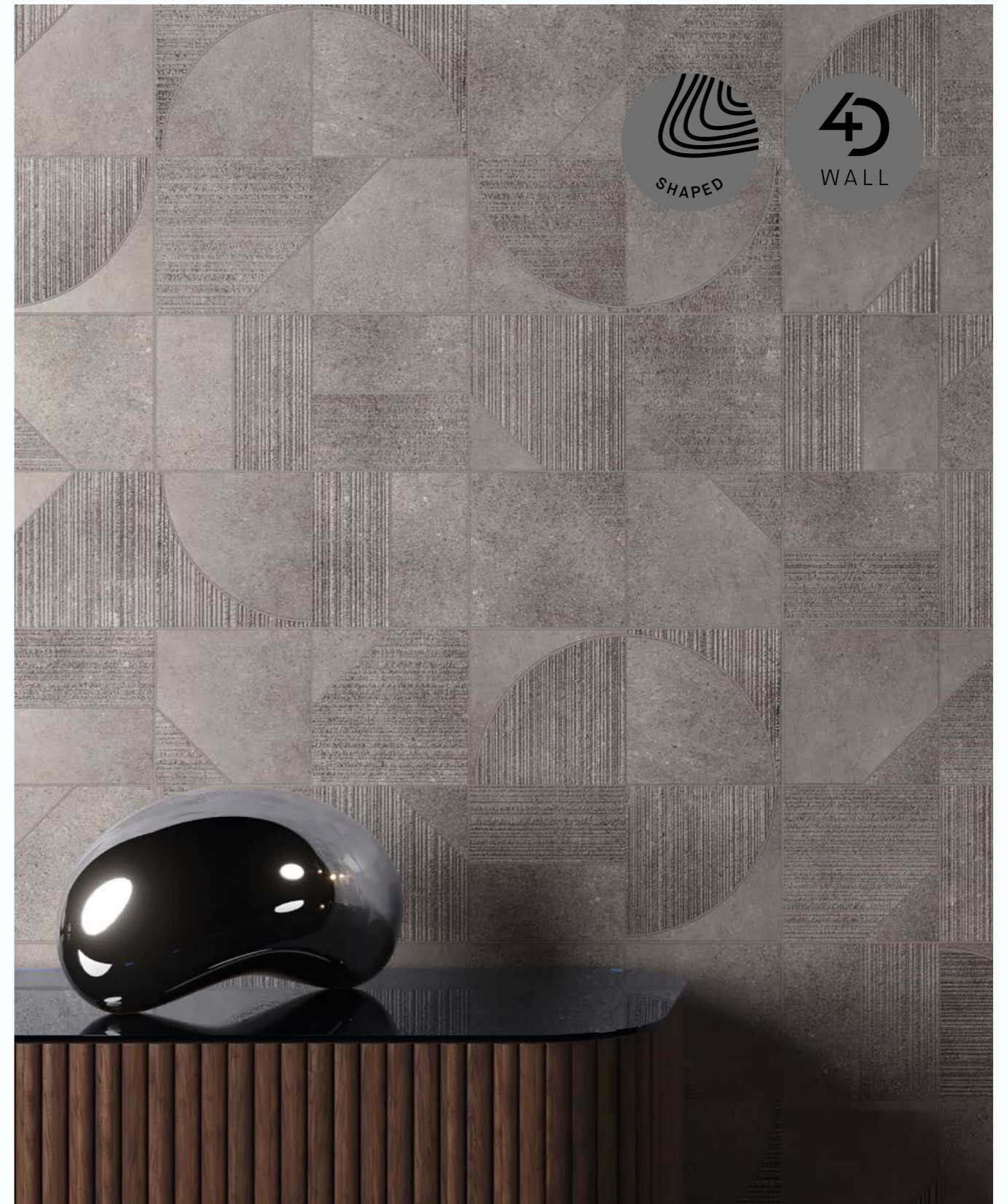

Ⓜ D.Chicago Moon Geo. SP/25x25



- Chicago Road/90X90/A/C/R & ANG. P.V. Road/A & E.P.V. Road/A & P.V. Road/A & REJ. Road/A & ANG.REJ. Road/A
- D.Chicago GEO. Road SP/25X25 & PL/18 Road/A

## POOL PIECES // PIEZAS DE PISCINA

Porcelain Porcelánico

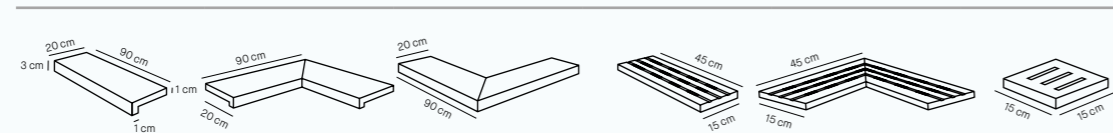

P.V. (POOL COPING)	ANG.P.V. (POOL COPING INTERNAL CORNER)	E.P.V. (POOL COPING EXTERNAL CORNER)	REJ. (DRAINAGE GRATE)	ANG.REJ. (ANGLE CORNER DRAINAGE GRATE)	T.REJ. (SQUARE CORNER DRAINAGE GRATE)
20x90x1 cm 8x35,4x0,4 "	90x90x1 cm 35,4x35,4x0,4 "	90x90x1 cm 35,4x35,4x0,4 "	15x45x2,3 cm 6x17,7x0,9 "	45x45x2,3 cm 17,7x17,7x0,9 "	15x15x2,3 cm 6x6x0,9 "

	CLOUD	ROAD	MOCHA	MOON
Antislip (A)	32228 M81	32229 M81	32230 M81	32231 M81
	32232 M75	32233 M75	32234 M75	32235 M75
	32236 M75	32237 M75	32238 M75	32239 M75
	32240 M54	32241 M54	32242 M54	32243 M54
	32244 M75	32245 M75	32246 M75	32247 M75
	32248 M71	32249 M71	32250 M71	32251 M71

## PACKING // PACKING

SIZE // FORMATO	BOX // CAJA			PALLET			CONTAINER 20' (24000 Kg.)			
	Piezas	m <sup>2</sup>	kg	Cajas	m <sup>2</sup>	kg	largo x alto x ancho	N° pallets	m <sup>2</sup>	kg
100 x 180 x 0,8	2	3,6	70,25	18	64,8	1315	190 x 115 x 60	17	1101,6	22347
100 x 100 x 0,8	2	2	36,8	32	64	1220	112 x 112 x 100	18	1152	23172
100 x 100 x 2	1	1	49,2	24	24	1223	112 x 112 x 85	20	480	23237
50 x 100 x 2	1	0,5	24,7	48	24	1227,6	112 x 112 x 85	20	480	23237
60 x 120 x 1	2	1,44	33,18	27	38,88	921	120 x 80 x 75	27	1049,8	24837
90 x 90 x 1	2	1,62	37,96	22	35,64	860	105 x 95 x 75	29	1033,6	24944
50 x 150 x 0,75	4	3	39,8	24	72	990	156 x 93 x 65	17	1224	16830
inch	Units	ft <sup>2</sup>	lb	Boxes	ft <sup>2</sup>	lb	length x height x width	N° pallets	ft <sup>2</sup>	lb
39,4 x 70,8 x 0,35	2	38,75	154,87	18	697,5	2900	71.2 x 44.1 x 25.2	17	11857.5	49267
39,4 x 39,4 x 0,35	2	21,53	81,13	32	688,9	2690	44.1 x 44.1 x 39.4	18	13088,9	51086
39,4 x 39,4 x 0,78	1	10,76	108,47	24	258,3	2696	44.1 x 44.1 x 33.5	20	4908,3	51229
19,7 x 39,4 x 0,78	1	5,38	54,45	48	258,3	2706	44.1 x 44.1 x 33.5	20	4908,3	51229
23,6 x 47,2 x 0,39	2	15,50	73,15	27	418,5	2030	47.2 x 31.4 x 29.5	27	11300	54755
35,4 x 35,4 x 0,39	2	17,44	83,68	22	383,6	1896	41.3 x 37.4 x 29.5	29	11125,2	54991
19,7 x 59,1 x 0,30	4	32,29	87,76	24	775	2183	61.4 x 36.6 x 25.6	17	13175	37119

## SLABS PACKING // PACKING DE PLACAS

SIZE // FORMATO	SLAB // PLACA			WOODEN CRATE // CAJÓN MADERA			CONTAINER 20' (24000 Kg.)			
	Piezas	m <sup>2</sup>	kg	Placas	m <sup>2</sup>	kg	largo x alto x ancho	Cajones	m <sup>2</sup>	kg
100 x 275 x 0,6	1	2,75	38,5	20	55	869	291 x 112 x 33 cm	24	1320	20856
inch	Units	ft <sup>2</sup>	lb	Slabs	ft <sup>2</sup>	lb	length x height x width	Crates	ft <sup>2</sup>	lb
39,4 x 108,3 x 0,24	1	29,6	84,88	20	592	1916	114.6 x 44 x 13 "	24	14208,4	45980

WOODEN CRATE  
CAJÓN MADERA

291 x 33 x 112 cm

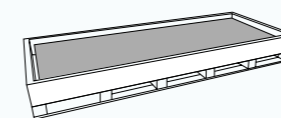

20 slabs placas



# MUSEUM

Once ceramic tiles reach the end of their useful life, they are inert waste. For their proper management, they should be given to an authorized waste management body for recycling purposes.

All colours and hues appearing in this catalogue should be considered approximate, only in view of the printing processes involved. The rights of all contents (texts, photographs, drawings, designs, etc.) of this catalogue remain the property of PERONDA GROUP S.A (or, failing that, they have the corresponding permissions of the owners). No part of this publication may be reproduced, stored in a retrieval system, or transmitted in any form or by any means, electronic, mechanical, photocopying, recording or otherwise, without the prior written permission of the copyright holders.

© PERONDA GROUP 2023

Las baldosas cerámicas una vez que llegan al final de su vida útil son un residuo inerte, que para su correcta gestión debe ser entregado a un gestor autorizado de residuos, favoreciendo su reciclado.

Debido a los procesos de impresión, los colores que aparecen en este catálogo deben considerarse aproximados, y no exactos. Los derechos de todos los contenidos (textos, fotografías, dibujos, diseños etc) del presente catálogo son propiedad de PERONDA GROUP, S.A (o en su defecto, cuentan con los correspondientes permisos y autorizaciones de sus titulares). No está permitida la reproducción total o parcial de esta publicación, ni su tratamiento informático, ni la transmisión de ninguna forma o por cualquier medio, ya sea electrónico, mecánico, por fotocopia, por registro u otros medios, sin el permiso previo y por escrito de los titulares del copyright.

Av. Manuel Escobedo, 26  
12200 Onda (Castellón) Spain  
+34 964 602 012

